

# YOURBLINDSSHOP

## HOW TO MEASURE A RECESS WINDOW - INSIDE MOUNT FIXING



A simple measure guide from YourblindsShop

We're here to help

✉ [sales@blindmatrix.com](mailto:sales@blindmatrix.com)

☎ +44 (0) 20 7096 1371

🌐 <https://blindmatrix.co.uk/>

### Before you start you will need:

- A good quality steel tape measure
- A spirit level
- Paper and pen

### Tips!

1. Note down your sizes.
2. Go have a break, then come back to double check your sizes before you place your order.
3. You may wish to upload a clear photo of your window with your order. This helps our team have a full understanding of your needs.

### What is a Recess?

The recess is the space created when a window or door is set back from the interior wall in the room. We recommend fitting shutters inside the recess (if available) as it is simple to both measure and install.

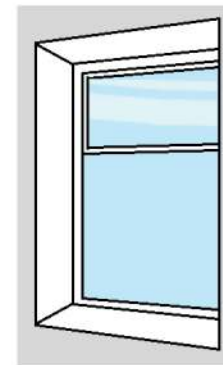

### Why should I order an Inside Mount Frame?

Inside Mount Frames are supplied with pre-drilled fixing holes. Holes are pre-drilled on the **INSIDE** of the frame to allow you to fit the frame **INSIDE** the recess. Your screws will fix into the recess walls and into the top and the bottom of the recess.

NOTE: Our frames are supplied with cover strips which hide all screws after installation!

**Design Tip:** Use your window for your starting point. Think about how you'd like the shutters to look but also how you'll use them. If you want to fold the panels open, do you have space?

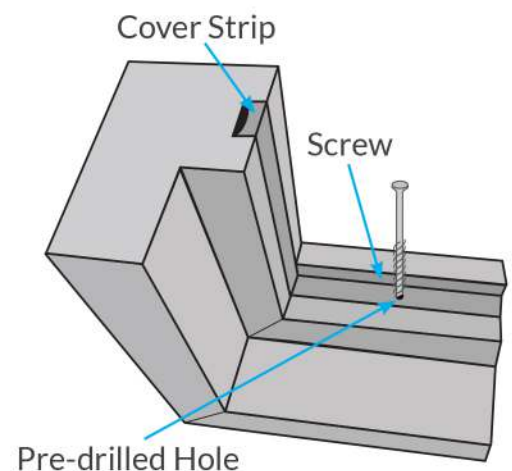

### How many Frame Sides?

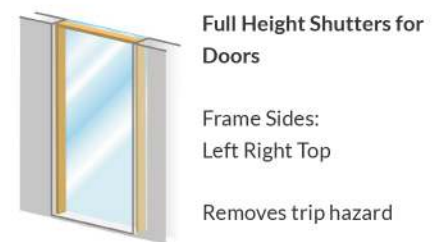

### Important to Note:

If your windows opens **inwards** contact us before measuring. You may need an alternative fitting for your window.

We're here to help

### Step 1: Choose Your Frame

We offer two types of inside mount frames.

#### 1. L Frame (IM)

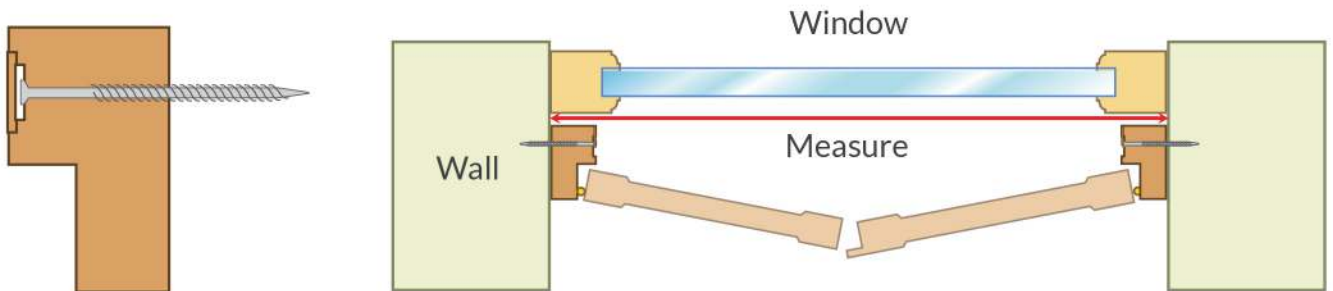

The inside mount L Frame allows shutters to be installed in the recess in 3 different positions.

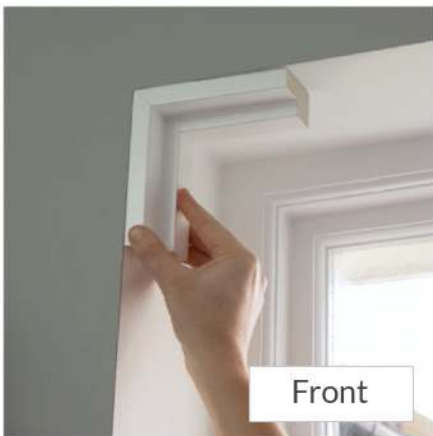

Front

Fit the L frame at the **front** of recess to allow panels fold back 180 degrees against the interior wall.

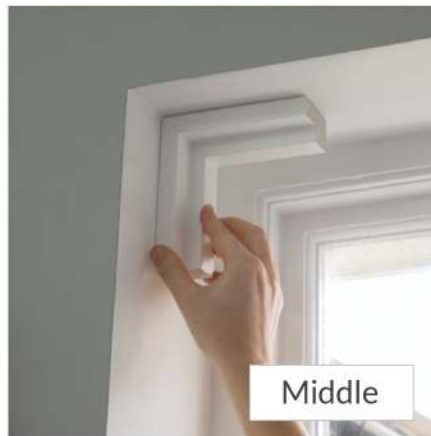

Middle

Fit the L frame in the **middle** of the recess and your panels fold back as far as the recess walls allow.

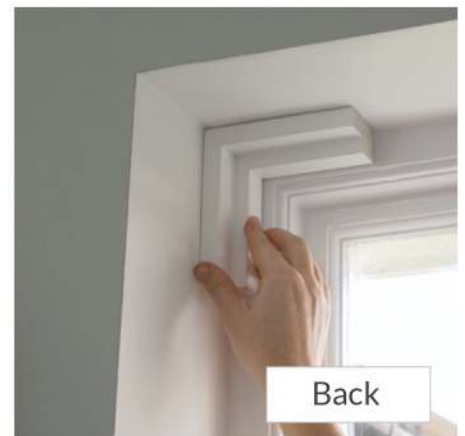

Back

Fit the L frame at the **back** of the recess as this leaves no gap between the back of shutter frame and recess.

**Important:** Measure the recess where you plan to fit the frame. Also measure the front opening to ensure the assembled frame can fit through.

We're here to help

### 2. Z Frame (IM)

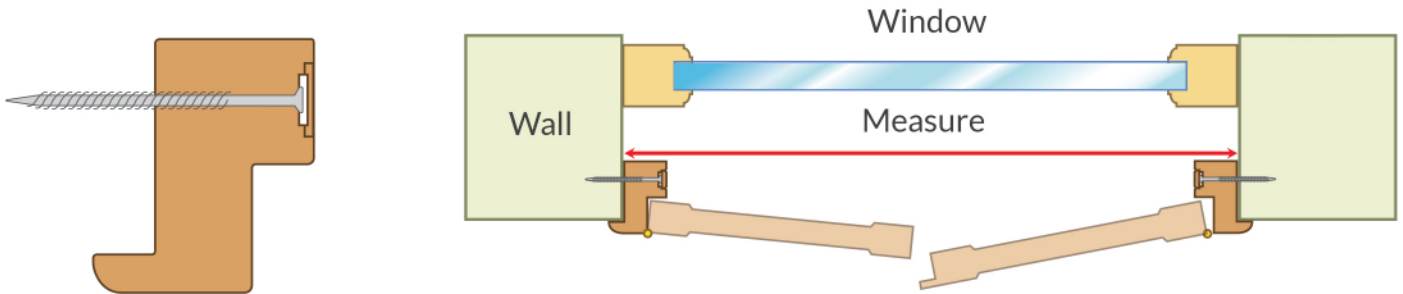

The Inside Mount Z frame is installed at the **front** of recess opening.

The Z frame wraps around the front edge of the recess and helps to conceal any gaps. It also allows the panels to fold back 180 degrees, unless obstructed by other furniture or room walls.

You must measure at the front of the recess and ensure that the recess depth is at least 38mm or 51mm to accommodate this frame.

**Important:** If you have a protruding window sill, you will need to order Frame Sides 'Left Right Top' or of the other options that includes a 'Sill Cut'.

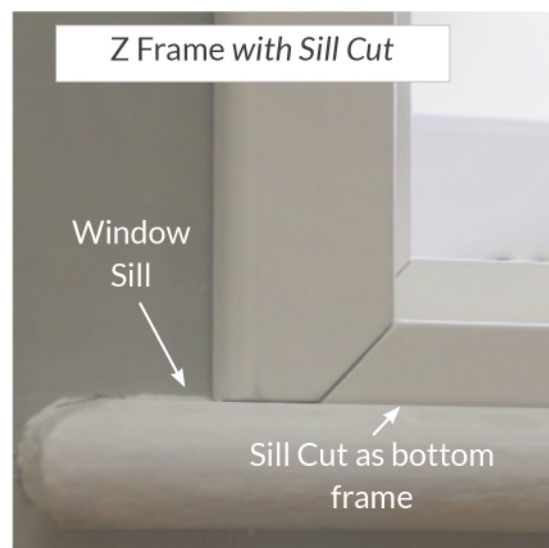

We're here to help

## Step 2: Measure Inside The Recess

1. Measure the **Width & Height** inside the recess in 3 different places. Note the **smallest** dimensions you find.

*If there are wall tiles, skirting boards or a kitchen upstand within the recess you could decide to remove them or if they stay, remember to measure in between these items to find your **smallest recess width**. Talk to our team for further advice!*

2. If you require a **Midrail**, measure from the bottom up to the point you'd like the midrail to be centred. We recommend trying to align this with any rail or mullion on your window.\*

3. To measure the height for the **Cafe Style** or **Tier on Tier Split**, measure from the bottom up to where you'd like the finished height of the **Cafe** or the lower **Tier on Tier** panel.

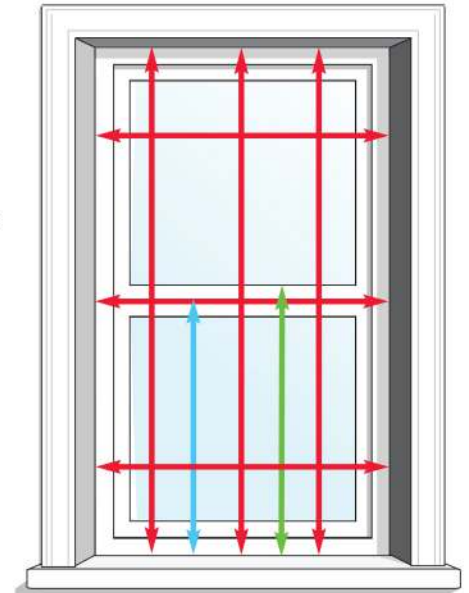

\* Please note manufacturing may need to move the midrail up or down from the dimensions you request to ensure that a 'whole' number of slats can fit in any given panel. If the midrail location is critical to your design, you must advise Us before Your order is finalised for production.

## Step 3: Deductions

We recommend deducting **4mm** from your smallest width and **4mm** from your smallest height.

This allows for the manufacturing tolerance (+/-2mm) and will certainly make fitting your shutters much easier. Remember not all recess areas are completely square and having wiggle room is helpful.

**Design Tip:** Remember an inside mount frame can be pulled forward in the recess to allow for handle clearance.

\* Please note that this document is a guide only and California Shutters cannot be held responsible for any mismeasurements.

We're here to help

## Frame Templates - Wood & Hybrawood

Once printed, please make sure that your templates are to scale. If not, you may need to adjust your printer settings and re-print.

Plain L 60mm

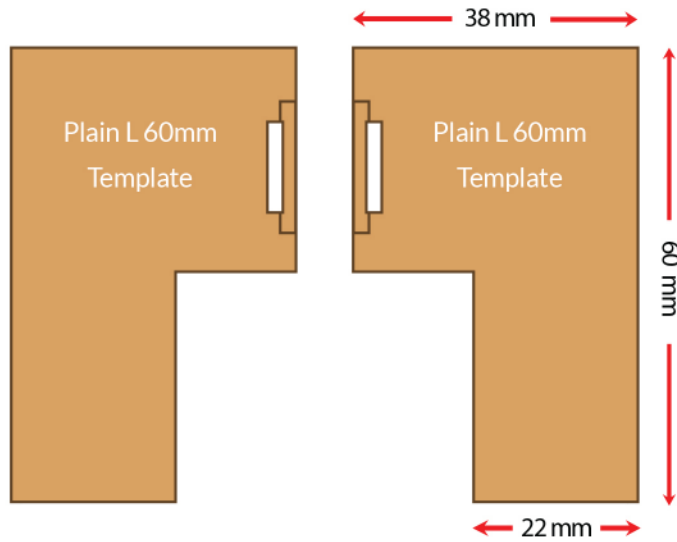

Bullnose Z

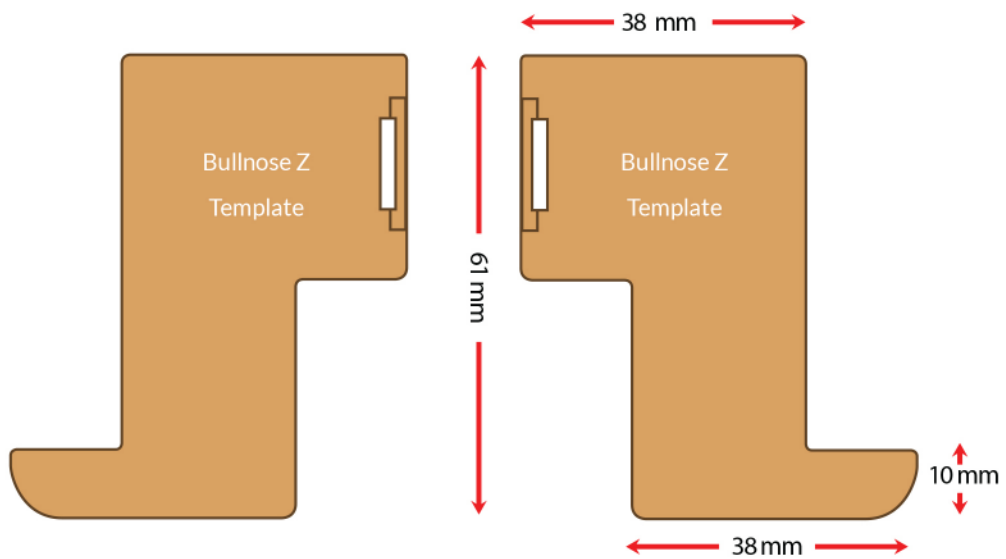

We're here to help

### Frame Templates - Waterproof PVC

Once printed, please make sure that your templates are to scale. If not, you may need to adjust your printer settings and re-print.

Beaded L 50mm (IM)

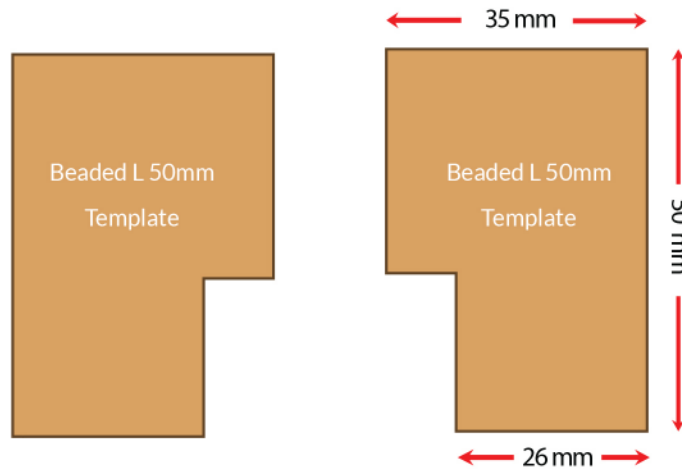

Classic Z

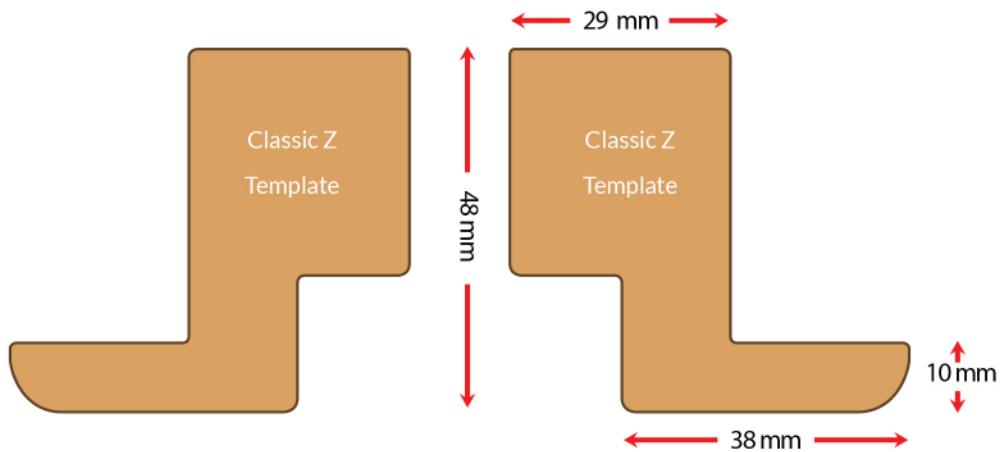

We're here to help